

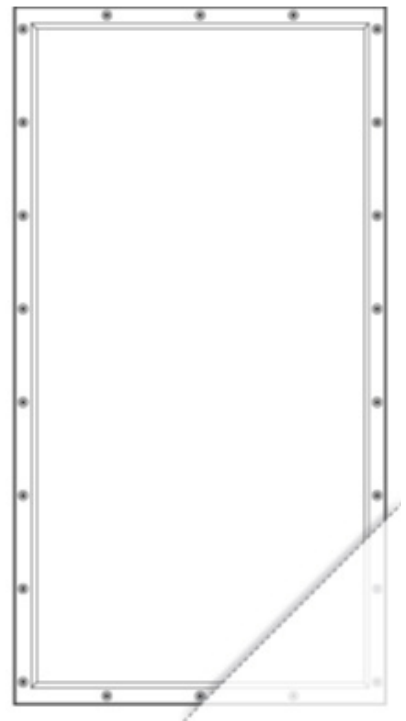

Conceal Series

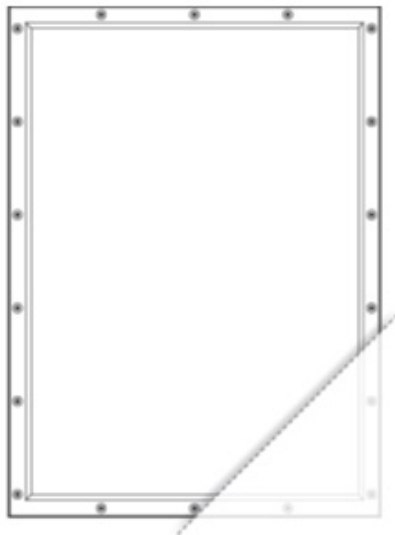
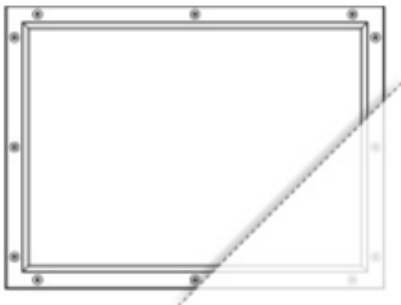

INTRODUCTION

Thank you for purchasing your new JBL Conceal Series Invisible architectural loudspeaker. This loudspeaker is designed to bring the best sound to your home while being completely invisible. We urge you to take a few minutes to read through this manual, which describes the product and includes step-by-step instructions for installing and finishing the speakers. These speakers are designed of high quality materials and with proper installation and care will last for many years.

CUSTOMER SUPPORT

Please contact your dealer if you have any questions about your product, its installation or its operation. For more information about this product including installation videos, or to contact JBL please visit our website at www.JBL.com.

BOX CONTENTS

	C62	C83	C86	C82W
Loudspeaker panels with back-box	1	1	2	2
Drywall shims	8	8	16	16
Drywall screws	13	19	31	46
Owner's manual	1	1	1	1

MINIMUM TOOLS REQUIRED FOR INSTALLATION

- Screwdriver
- Wire strippers
- Level
- Stud Finder
- Saw

SPEAKER PLACEMENT

JBL Conceal Invisible Loudspeakers are designed for in-wall and in-ceiling installation in standard drywall construction. For stereo or home theater listening, position the loudspeakers at ear-level and position the left and right speakers closely with the television (See Figure 1 and Figure 2).

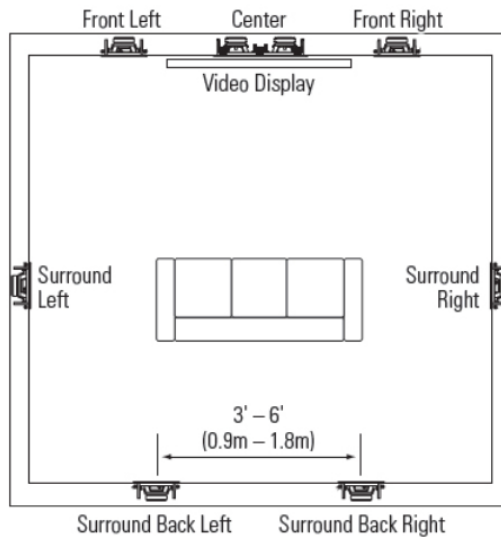

Figure 1

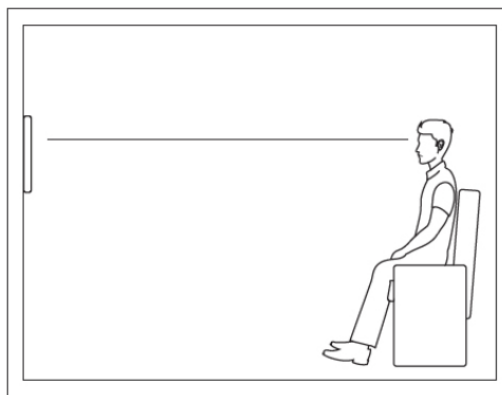

Figure 2

For background listening, you can place your speakers in any convenient location to distribute sound throughout the room (See Figure 3).

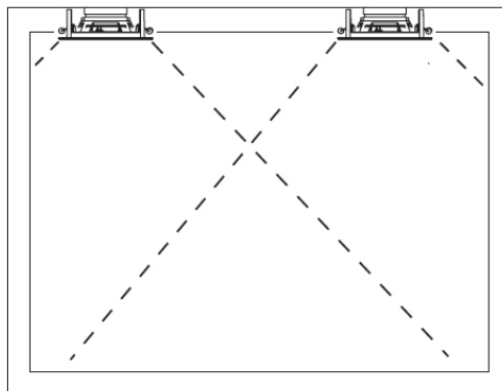

Figure 3

BEFORE INSTALLING SPEAKERS

- Conceal series loudspeakers require a stable mounting structure for proper support. Speakers should only be attached to non-moveable elements of a building such as a structural ceiling or structural wall and must allow for screw attachment of all four sides of the speaker and the adjoining wallboard. Well-cured and dry structural pine 2" x 4" studs (35 x 70 mm) can be used for such framing if the existing construction does not provide the required stable mounting structure. If the stable mounting structure is in a lowered ceiling, then you must use ceiling hangers to directly secure the mounting structure to the building structural ceiling. Mount the speaker to the stable mounting structure per Conceal series speaker installation instructions.
- Do not install Conceal series speakers before the wallboard is hung, instead install a pre-construction board (PCB) where each speaker will be located. Exposing speakers to the construction environment during the installation of wallboard runs the risk of damage and improper alignment with the surrounding wallboard.

SPEAKER WIRING

- JBL recommends using 16 gauge AWG speaker wire for runs of less than 100 ft (30.5 m) and 14 gauge AWG speaker wire for runs of 100 ft to 250 ft (30.5 m - 76 m).
- Attach speaker wiring securely to the studs. Make sure to properly connect the speaker wires to the speaker binding posts; jiggle the wires and re-tighten.

SPEAKER INSTALLATION: RETROFIT

- Installing a Conceal Invisible Loudspeaker into an existing finished wall is similar to making a wallboard patch.
- Remove the overlay sheet that comes attached to the front of each speaker and temporarily attach them to the walls to assist in planning speaker placement and for tracing the cutout opening.
- Once the approximate speaker locations have been selected, use a stud finder to locate the framing and drill test holes to verify. Align the edges of the overlay sheet so they are centered on the framing. Cut the wallboard to the size of the speaker using the overlay. The finished opening should be 16" wide and centered on the framing studs.
- Proceed to Installation Step 2 "Speaker Alignment and Test Fit".

SPEAKER INSTALLATION: NEW CONSTRUCTION

1. Framing & Pre-construction Brackets (PCB)

- For retrofits and for new construction, it is recommended to add cross member framing above and below the speaker opening so that the speaker may be attached on all four sides.
- In new construction, pre-construction brackets (PCB) should be installed when the job is pre-wired. Center the PCB on the framing and attach with provided hardware. This reserves the exact space for the speaker during the wallboard installation preventing the speaker panel itself from exposure to harsh construction environment and also force the wallboard installers to hang the wallboard around the PCB leaving a perfectly sized opening for the speaker.

2. Speaker Alignment and Test Fit

- After the wallboard has been installed, remove the pre-construction board (PCB).
- Before seam finishing occurs, it is critical to test fit each speaker to check its registration with the surrounding wallboard. For correct registration, the perimeter screw flange of the speaker panel should be flush with the adjoining wallboard (See Figure 4). This creates a recess for seam tape to prevent sanding back into the tape during the finishing process.
- If necessary, attach the provided self-adhesive shims to the rear of the speaker. Place the shims over the screw holes and leave no gaps (See Figure 5).
- It is critical to add the correct number of shims so that the wallboard and flange surfaces are flush with one another. If the speaker is recessed in relation to the wallboard excessive material build-up on the surface of the speaker can occur during the finishing process which may lead to poor sound quality and possible premature failure.

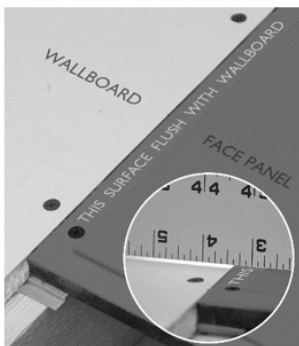

Figure 4

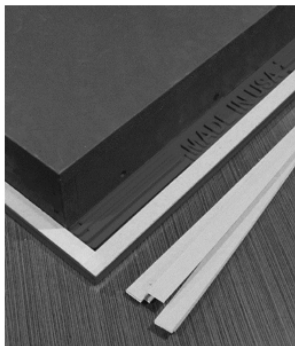

Figure 5



Figure 6

3. Connect Speaker Wires

- Insert the speaker wires into the binding posts on the speaker noting proper polarity.

4. Speaker Mounting

- Attach the speaker panel screw flanges directly to the structural framing using the provided wallboard screws (See Figure 6). The panels have been pre-drilled with the proper number of holes. Be sure that all of the screws are installed and that they hold securely to the framing.
- Add screws to the wallboard surrounding the speaker as well.
- Do not use nails.

TIP: Make sure the tip of the screw is on the side of the screw hole toward the outside edge. This creates an outward pull or stretching effect on the speaker.

5. Recheck Speaker Registration

- Once the speaker is secured, recheck that the outer flange of the speaker is flush with the surrounding wallboard.
- Place a 4-foot straight edge across middle of the speaker to verify that the speaker face protrudes approximately 1/16" (2mm) beyond the wallboard in each direction.
- Check that the speaker is not warped from strain caused by uneven framing. A warped speaker frame will cause the speaker face to bulge.
- Having the correct registration minimizes the amount of joint compound that might be built up over the face of the speaker during the finishing process. This 1/16" (2mm) protrusion of the speaker face will become invisible after the seams are properly finished and joint compound is feathered out from the front of the speaker appropriately.

TIP: If you tried to tighten the screws but unable to achieve a satisfactory result, try placing approximately 4" (102 mm) of thin shim material under the mounting flange at the center point.

6. Test Speaker Sound

- Before proceeding with any wall finishing, test each speaker with an amplified sound source.
- Test with music at listening volume in addition to test tones to ensure full functionality. Make note of sound coming from high, mid, and low frequency drivers of each speaker. Check for any rattling or vibration.
- Now is the time to correct any potential issues.

7. Seam Finishing

- After the registration and sound check, seam finishing can proceed. The speaker panel should be finished in-place, similar to any other piece of wallboard.
- Self-adhesive nylon mesh tape is recommended due to its ease of use, however paper tape is also acceptable (See Figure 7).
- Use only air-dry joint compounds and plasters for seam finishing. Do not use chemically curing joint compound.
- For best results, we recommend at least three light applications of joint compound, sanding between coats.
- Allow 24 hours between each application of joint compound for complete drying. Failure to allow the joint compound to completely dry between applications may result in fine hairline cracking around the speaker.
- The joint compound should be spread beginning 2"-3" in from the speaker edge and then feathering outward 16"-20" in order to achieve a smooth, flat transition.
- It is important that enough joint compound be applied around the speaker to make a very gradual transition from the surface of the wallboard to the face of the speaker panel. Every situation is different, but it will normally take at least a 16"-20" (30cm) fan of joint compound around the perimeter of the panel to create a flat-looking transition.
- Be sure to feather the joint compound away from the speaker as to not build up more than the maximum allowed 1/16" (2 mm) of joint compound over the face of the speaker panel (See Figure 8).
- Conceal series speakers do not require a skim coat to attain a smooth finish. However, some advanced finishing techniques and materials such as Venetian plaster or heavy plaster coats may require skimming over the front of the speaker. In these situations, it may be necessary to shim the speaker proud of the surrounding wallboard so that we avoid build-up of more than 1/16" (2 mm) in thickness on the face of the speaker.



Figure 7



Figure 8



Figure 9

8. Sand Smooth

- Sanding is the last important step before the painting begins. This can make or break the quality of the installation.
- When sanding, imperfections in the application of the joint compound may appear. If so, additional joint compound and sanding may be needed to create a seamless transition (See Figure 9).
- Best practice may include the use of a flashlight to shine sheer light down the wall or ceiling in order to identify high/low spots in the finish work.

9. Paint and Finish

- Once sanding is complete the face panel is ready for painting (See Figure 10).
- Prime the speaker and surrounding areas with an adhesive type of water based primer.
- Light "orange peel" texture, light knock-down texture, wallpaper, veneer, or level 5 finish may be applied.
- Heavy knock down or trowel finishes are not recommended. Conceal series speaker face panels are engineered for optimum audio performance with no more than 1/16" (2mm) of any material applied to the surface of the speaker.



Figure 10

REPAIR & REUSE

Hairline Cracking Causes and Repair

JBL Conceal Invisible Loudspeakers are designed specifically to prevent cracking of the wallboard finish around the perimeter of the speaker during normal use. This is accomplished by dampening the frame of the speaker from vibrations caused during playback. By isolating the frame from vibration, movement between the speaker and surrounding wallboard is minimized which eliminates the opportunity for cracking to occur.

If fine hairline perimeter cracking does occur soon after installation, it is most commonly associated with insufficient drying time of the base coat of joint compound. It is critical that each coat of joint compound is completely dry when a subsequent layer is applied. Any moisture retained in the base layer will continue to slowly dry and shrink slightly under the subsequent layers of joint compound. This shrinking process may produce delayed hairline cracking.

This type of cracking does not typically appear at the seam between the wallboard and speaker, rather at the chamfered edge of the speaker diaphragm about 3/4" (19 mm) inward from the edge of the speaker frame. Cracking may not be visible right away as it may take days or weeks for the base coat to completely dry.

The best way to prevent this type of cracking is to allow additional drying time for the base coat of joint compound, especially in areas where the construction environment is cold or damp. THE USE OF HOT MUD OR CHEMICALLY CURING JOINT COMPOUNDS IS NOT ADVISED.

Repairing this type of hairline perimeter cracking should be done with standard wall-finishing techniques:

- For smooth wall/ceiling finishes, repair usually consists of excavation of the crack using a sharp tool such as the corner of a chisel or utility knife. Using the sharp tool, widen the crack to 1/16" to 1/8" (2-3 mm). Next fill/skim the affected area with lightweight joint compound or spackle. Use air-dry type compounds only. Once completely dry, sand the area smooth flat and re-paint.
- For textured wall/ceiling finishes, or finishes less critical, it is possible to repair the cracks with a water-based paintable caulk. Using a putty knife or fingertip, push the caulk into the crack. Use a damp cloth to wipe away the excess. Allow to dry and then paint.

TROUBLESHOOTING

Sound cuts out or is distorted

JBL Conceal invisible loudspeakers contain self-resetting limit switches for protection against excessive amplifier output. These switches respond to the heat generated from the excessive volume output and will be triggered before output reaches levels that could damage the speaker. Sound quality may be greatly reduced as the limit is approached but the speaker and amplifier will not be damaged. Once fully triggered, audio output will cease until the excessive volume has been corrected and the limit switch returns to its normal operational state (approx. 5-10 minutes).

Some speakers may contain up to three independent switches for high-frequency, low frequency and mid-range frequency. Depending on the frequencies in the audio being played one or more limit switch may be triggered while the remaining frequency ranges may continue to output normally. In any case, pause the audio or reduce the volume level until the limit switches have returned to their operational state.

WARNING

HARMAN International assumes no responsibility for improper installation of hardware or for any personal injuries or product damages resulting from improper installation or a fallen loudspeaker.

LIMITED WARRANTY

JBL Conceal Invisible Loudspeakers are warranted against defects. The duration of the speaker's warranty depends on the laws in the country in which it was purchased. Your local JBL retailer can help you determine the length of your warranty.

SPECIFICATIONS

Specifications	C62	C83	C86	C82W
Type:	2-way	3-way	2-Panel 3-way	2-Panel Subwoofer system
LF Driver:	6.5-inch (165mm) woofer	8-inch (203mm) woofer	8-inch (203mm) woofer	8-inch (203mm) woofers (2 per panel)
MF Driver:	N/A	1.18-inch (30mm) transducer	Four 1.18-inch (30mm) transducers	N/A
HF Driver:	1.18-inch (30mm) transducer	1-inch (25mm) transducer	1-inch (25mm) transducer	N/A
Input Power:	50 - 100 WRMS	50 - 160 WRMS	50 - 200 WRMS	60 - 100 WRMS (per panel)
Impedance:	4 Ohm	4 Ohm	4 Ohm	Selectable 4 Ohm or 16 Ohm (each panel)
Sensitivity:	83 dB/1W/1m measured in-room	84 dB/1W/1m measured in-room	84 dB/1W/1m measured in-room	86 dB/1W/1m measured in-room
Frequency Response:	45 Hz - 20 kHz (-6 dB) measured in-room	45 Hz - 20 kHz (-6 dB) measured in-room	45 Hz - 20 kHz (-6 dB) measured in-room	30 Hz - 300 Hz (-6 dB) measured in-room
Crossover Frequency:	600 Hz	500 Hz	600 Hz; 10 kHz	N/A (requires amplifier with HPF and LPF)
Enclosure Type:	Sealed, with wooden back-box	Sealed, with wooden back-box	Sealed, with wooden back-box	Sealed, with wooden back-box
Panel Dimensions:	11-7/8" H x 15-7/8" W x 3-7/8" D (302mm H x 403mm W x 98mm D)	22" H x 15-7/8" W x 3-7/8" D (559mm H x 403mm W x 98mm D)	MF/HF Panel: 11-7/8" H x 15-7/8" W x 3-7/8" D (302mm H x 403mm W x 98mm D) LF Panel: 22" H x 15-7/8" W x 3-7/8" D (559mm H x 403mm W x 98mm D)	30" H x 15-7/8" W x 3-7/8" D (762mm H x 403mm W x 98mm D)
Cut-out Dimensions:	12" H x 16" W (305mm H x 406 W)	22-1/8" H x 16" W (562mm H x 406mm W)	MF/HF Panel: 12" H x 16" W (305mm H x 406mm W) LF Panel: 22-1/8" H x 16" W (562mm H x 406mm W)	30-1/8" H x 16" W (765mm H x 406mm W)
Mounting Depth:	3-3/8-inches (86mm)	3-3/8-inches (86mm)	3-3/8-inches (86mm)	3-3/8-inches (86mm)
Pre-construction Board (PCB):	C12PCB	C22PCB	MF/HF Panel: C12PCB LF Panel: C22PCB	C30PCB
Protection:	Two independent self-resetting devices (LF and HF)	Two independent self-resetting devices (LF and MF/HF)	Three independent self-resetting devices (LF, MF and HF)	N/A (requires amplifier with limiter)

Торговая марка:	JBL
Назначение товара:	Закладная панель для монтажа
Изготовитель:	Харман Интернешнл Индастриз Инкорпорейтед, США, 06901 Коннектикут, г.Стэмфорд, Атлантик Стрит 400, офис 1500
Страна происхождения:	Сделано в США
Импортер в Россию:	ООО «ХАРМАН РУС СиАйЭс», 127018, г.Москва, ул. Двинцев, д.12, к 1
Гарантийный период:	1 год
Информация о сервисных центрах:	www.harman.com/ru тел. +7-800-700-0467
Срок службы:	5 лет
Товар сертифицирован	
Дата производства:	Дата изготовления устройства определяется по двум буквенным обозначениям из второй группы символов серийного номера изделия, следующих после разделительного знака «-». Кодировка соответствует порядку букв латинского алфавита, начиная с января 2010 года: 000000-MY0000000, где «M» - месяц производства (А - январь, В - февраль, С - март и т.д.) и «Y» - год производства (А - 2010, В - 2011, С - 2012 и т.д.).

Используйте устройство только по прямому назначению в соответствии с предоставленной инструкцией. Не пытайтесь самостоятельно вскрывать корпус товара и осуществлять ремонт. В случае обнаружения недостатков или дефектов, обращайтесь за гарантийным обслуживанием в соответствии с информацией из гарантийного талона. Особые условия хранения, реализации и (или) транспортировки не предусмотрены. Избегайте воздействия экстремальных температур, длительного воздействия влаги, сильных магнитных полей. Устройство предназначено для работы в жилых зонах. Срок годности не ограничен при соблюдении условий хранения. Пожалуйста, не утилизируйте устройства с литий-ионными аккумуляторами вместе с бытовыми отходами.

产品中有害物质的名称及含量

部件名称	目标部件	有害物质或元素					
		铅 (Pb)	汞 (Hg)	镉 (Cd)	六价铬 (Cr(VI))	多溴联苯 (PBB)	多溴二苯醚 (PBDE)
箱体	外壳, 面板, 背板等	0	0	0	0	0	0
零部件	喇叭, 电容, 连接器	X	0	0	0	0	0
附件	连接线, 说明书, 包装等	0	0	0	0	0	0

本表格依据 SJ/T 11364 的规定编制

0: 表示该有害物质在该部件所有均质材料中的含量均在 GB/T 26572 规定的限量要求以下。

X: 表示该有害物质至少在该部件的某一均质材料中的含量超出 GB/T 26572 规定的限量要求。



在中华人民共和国境内销售的电子电气产品上将印有“环保使用期”(EUP) 符号。

圆圈中的数字代表产品的正常环保使用年限。



8500 Balboa Boulevard, Northridge, CA 91329 USA

© 2020 HARMAN International Industries, Incorporated. All rights reserved. JBL is a trademark of HARMAN International Industries, Incorporated, registered in the United States and/or other countries.
Features, specifications and appearance are subject to change without notice.



Part No. 950-0576-001 Rev.X2

For additional languages, please visit www.jbl.com
Pour les autres langues, veuillez visiter www.jbl.com
Informationen in weiteren Sprachen finden Sie unter www.jbl.com
Если вам нужны версии на других языках, перейдите на сайт www.jbl.com
他の言語で読むには、www.jbl.com にアクセスしてください
Para obtener otros idiomas, visite www.jbl.com
Para obter o manual do usuário em outros idiomas, acesse www.jbl.com
추가 언어에 대해서는 www.jbl.com 에서 확인하십시오
如需其他语言，请访问 www.jbl.com